

US PRODUCT SHEET

SUMATRA V LED



AAE SUMATRA V LED US FP Non contractual picture.



Alain Ellouz
.paris

Type	Pendant light Equipped with UL listed components
Environment	Indoor
Material	Alabaster and steel
Suspension system	Metal rod Ø0,5" - Standard length to order : min. 8" - max. 79" Additional length to order (Price upon request)
Lighting system	LED Strip 2,9W/ft (2700K or 3000K) - Dimmable intensity Standard : remote transformer Optional (additional cost) : transformer concealed in canopy
Voltage	24 V : transformer provided
Wattage	SUMATRA V80 : 16 W SUMATRA V120 : 23 W
Source lumens	SUMATRA V80 : 980 lm SUMATRA V120 : 1400 lm The alabaster diffuses between 40 and 60% of the light source lumens
References	SUMATRA V80 : COL-0238 SUMATRA V120 : COL-0234

Dimensions :

SUMATRA V80

SUMATRA V120

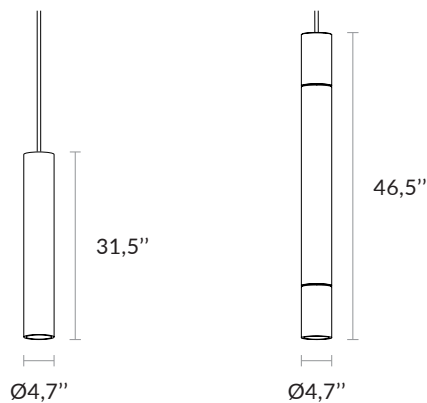

Weight/ Poids :

18 lb / 8 Kg

26 lb / 12 Kg

2 years warranty. General terms and conditions of sales.

STANDARD FIXING SYSTEMS AND FINISHES

Included in the price of the luminaire

The price includes the fixing system of your choice, with a standard finish and a rod of 2 meters maximum.
(price on request for a longer rod)

- **HIDDEN INDIVIDUAL FIXING**

System adapted to false ceilings for an aspect without a visible fixation (the rod comes out directly from the ceiling).
The hole in the false ceiling can be finished with an eyelet .

3,5 x 1,2 x h.0,9"

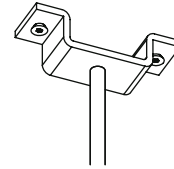

- **CANOPY 130**

Individual ceiling fixing.

Ø 5,1 x h.1,4"

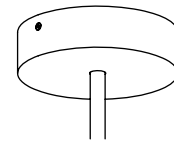

- **RODS AND CANOPY 130 FINISHES**

Paint finishes :



Mat white
ref : dcl-012



Mat black
ref : dcl-022



Bronze
ref : dcl-016

OPTIONAL FINISHES : rods and canopy 130

Price upon request

Metal plating finish

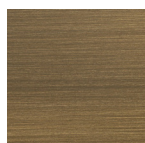

Antique brass
ref : dcl-005

Steel finish



Polished stainless steel
ref : dcl-003

Please contact us for any request of custom-made ceiling plate.

US PRODUCT SHEET

SUMATRA VF LED



Non contractual picture.

AAE SUMATRA VF US FP



Alain Ellouz
.paris

Type	Pendant light Equipped with UL listed components
Environment	Indoor
Material	Alabaster and steel
Suspension system	Metal rod Ø0,5" - Standard length to order : min. 8" - max. 79" Additional length to order (Price upon request)
Lighting system	LED Strip 9,6W/m (2700K or 3000K) - Dimmable intensity Standard : remote transformer Optional (additional cost) : transformer concealed in canopy
Voltage	24 V : transformer provided
Wattage	SUMATRA VF80 : 16 W SUMATRA VF120 : 23 W
Source lumens	SUMATRA AF80 : 980 lm SUMATRA AF120 : 1400 lm The alabaster diffuses between 40 and 60% of the light source lumens
Reference	SUMATRA VF80 : COL-0357 SUMATRA VF120 : COL-0356

Dimensions :

SUMATRA VF80

SUMATRA VF120

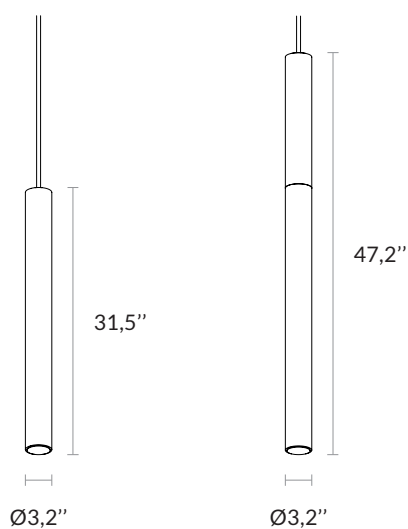

Weight :

13 lb / 6 Kg

18 lb / 8 Kg

2 years warranty. General terms and conditions of sales.

STANDARD FIXING SYSTEMS AND FINISHES

Included in the price of the luminaire

The price includes the fixing system of your choice, with a standard finish and a rod of 2 meters maximum.
(price on request for a longer rod)

- **HIDDEN INDIVIDUAL FIXING**

System adapted to false ceilings for an aspect without a visible fixation (the rod comes out directly from the ceiling).
The hole in the false ceiling can be finished with an eyelet .

3,5 x 1,2 x h.0,9"

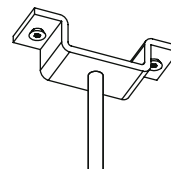

- **CANOPY 130**

Individual ceiling fixing.

Ø 5,1 x h.1,4"

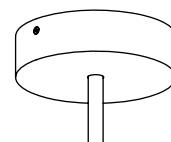

- **RODS AND CANOPY 130 FINISHES**

Paint finishes :



Mat white
ref : dcl-012



Mat black
ref : dcl-022



Bronze
ref : dcl-016

OPTIONAL FINISHES : rods and canopy 130

Price upon request

Metal plating finish



Satin brass
ref : dcl-009

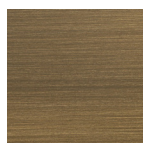

Antique brass
ref : dcl-005

Steel finish



Polished stainless steel
ref : dcl-003

Please contact us for any request of custom-made ceiling plate.

US PRODUCT SHEET

SUMATRA VF50 SPOT



AAE SUMATRA VF50 SPOT US FP - Non contractual picture.



Alain Ellouz
.paris

Type	Pendant light Equipped with UL listed components
Environment	Indoor
Material	Alabaster and steel
Suspension system	SUMATRA VF50 SPOT : Metal rod Ø0,5" - Standard length to order : min. 19,7" - max. 79" Additional length to order (Price upon request)
Socket	E26
Recommended bulb	LED bulb E26 - 2700K - 6W - 470 lm - dimmable intensity
Voltage	120 V (US)
References	SUMATRA VF50 SPOT : COL-0236

Dimensions :

SUMATRA VF50

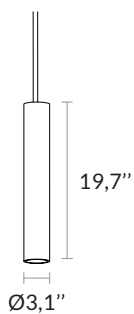

Weight :

6,6 lb / 3 Kg

2 years warranty. General terms and conditions of sales.

STANDARD FIXING SYSTEMS AND FINISHES

Included in the price of the luminaire

The price includes the fixing system of your choice, with a standard finish and a rod of 2 meters maximum.
(price on request for a longer rod)

- **HIDDEN INDIVIDUAL FIXING**

System adapted to false ceilings for an aspect without a visible fixation (the rod comes out directly from the ceiling). The hole in the false ceiling can be finished with an eyelet. In this case, the wiring of the luminaire is done by the installer, who is responsible for compliance with standards.

3,5 x 1,2 x h.0,9"

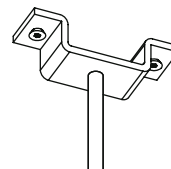

- **CANOPY 130**

Individual ceiling fixing.

Ø 5,1 x h.1,4"

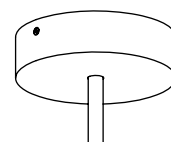

- **RODS AND CANOPY 130 FINISHES**

Paint finishes :



Mat white
ref : dcl-012



Mat black
ref : dcl-022



Bronze
ref : dcl-016

OPTIONAL FINISHES : rods and canopy 130

Price upon request

Metal plating finish



Satin brass
ref : dcl-009

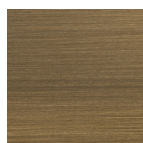

Antique brass
ref : dcl-005

Steel finish



Polished stainless steel
ref : dcl-003

Please contact us for any request of custom-made ceiling plate.

US PRODUCT SHEET

SUMATRA v80 SPOT



AAE SUMATRA V80 SPOT US FP. Non-contractual picture.



Alain Ellouz
.paris

Type	Pendant light Equipped with UL listed components
Environment	Indoor
Material	Alabaster and steel
Suspension system	SUMATRA V80 SPOT : Metal rod Ø0,5" - Standard length to order : min. 8" - max. 79" Additional length to order (Price upon request)
Socket	E26
Recommended bulb	LED bulb E26 - 2700K - 6W - 470 lm - dimmable intensity
Voltage	120 V (US)
References	SUMATRA V80 SPOT : COL-0240

Dimensions : SUMATRA V80

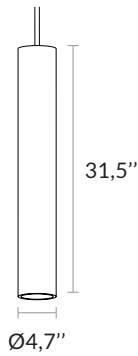

Weight : 17,6 lb / 8 Kg

2 years warranty. General terms and conditions of sales.

STANDARD FIXING SYSTEMS AND FINISHES

Included in the price of the luminaire

The price includes the fixing system of your choice, with a standard finish and a rod of 2 meters maximum.
(price on request for a longer rod)

- **HIDDEN INDIVIDUAL FIXING**

System adapted to false ceilings for an aspect without a visible fixation (the rod comes out directly from the ceiling). The hole in the false ceiling can be finished with an eyelet. In this case, the wiring of the luminaire is done by the installer, who is responsible for compliance with standards.

3,5 x 1,2 x h.0,9"

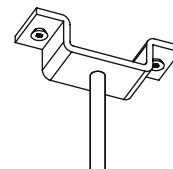

- **CANOPY 130**

Individual ceiling fixing.

Ø 5,1 x h.1,4"

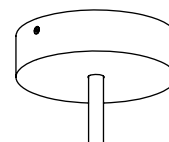

- **RODS AND CANOPY 130 FINISHES**

Paint finishes :



Mat white
ref : dcl-012



Mat black
ref : dcl-022



Bronze
ref : dcl-016

OPTIONAL FINISHES : rods and canopy 130

Price upon request

Metal plating finish



Satin brass
ref : dcl-009

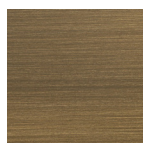

Antique brass
ref : dcl-005

Steel finish



Polished stainless steel
ref : dcl-003

Please contact us for any request of custom-made ceiling plate.